

A photograph of a modern wooden deck with a glass railing system. The deck is made of dark wood planks and features a stainless steel post-and-rail system with clear glass panels. In the background, there is a wooden building with large windows and a view of a green, hilly landscape under a blue sky.

INVISIRAIL™
GLASS RAIL SYSTEM™

Clearly the best choice!

GET THE LOOK

- STAINLESS STEEL (SS) INVISIPOSTS
- SS CONNECTORS
- 10mm TEMPERED SAFETY GLASS

InvisiRail.com

Get the look you've always wanted

You've worked hard to create that view. Choose InvisiRail for the best sight lines while providing safety and security for your family.

Our 10mm thick safety glass is tempered and heat soaked for strength and durability, engineered for building code compliance.

With 23 standard panel sizes and customizable options, we can design a system to fit virtually any deck.

- SS INVISIPOSTS AND EXISTING WOOD POSTS
- SS CONNECTORS
- 10mm TEMPERED SAFETY GLASS

Make the most of your view

InvisiRail is the only glass railing system on the market that can span up to six feet with a single panel. With the lowest profile post and no top or bottom rail you experience the ultimate in wide open viewing.

Add our 25-year warranty, immediate delivery and ease of installation and the choice is clear!

- SS INVISIPOSTS
- SS CONNECTORS
- 10mm TEMPERED SAFETY GLASS

Many top rail options available



- SS INVISIPOSTS
- SS CONNECTORS
- 10mm TEMPERED SAFETY GLASS
- 42mm SS TOP RAIL

Some jurisdictions are now mandating a top rail with glass guard rails. We've engineered a complete top rail system that can be included or retrofitted onto our railings.

Strong stainless steel brackets attach to the posts to secure a secondary fail-safe rail in the event of a glass panel being shattered.

Choose our elegant stainless steel piping or use your own pressure-treated, cedar or composite board. All options are building code compliant.



Hardware and connectors



Multi-angle adapter accommodates any angle required up to 95 degrees

All our stainless steel connectors and accessories are 316 grade steel and have undergone a passivation process to further enhance corrosion resistance.

Our nuts, bolts and connection hardware are also 316 steel ensuring that you will enjoy years of trouble free performance.

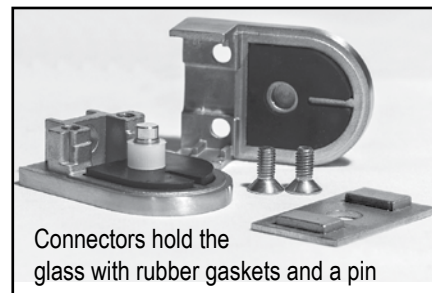

Connectors hold the glass with rubber gaskets and a pin



45 degree angle wedge

Lite10 nylon connectors

Our Lite10 hardware provides a more affordable option.

Available in black, white or cedar, they can attach to any flat surface.

Stackable wedges can handle angle combinations in 11.25 and 45 degree increments.

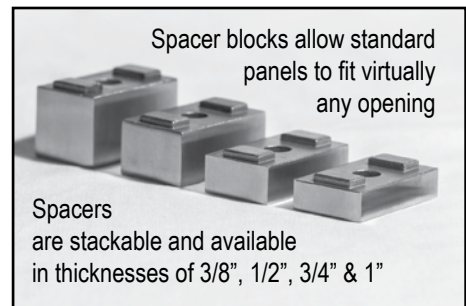
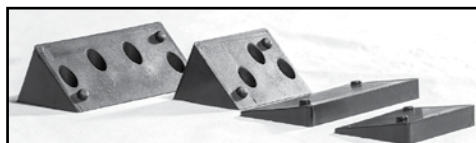
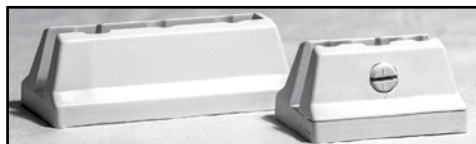

Spacer blocks allow standard panels to fit virtually any opening

Spacers are stackable and available in thicknesses of 3/8", 1/2", 3/4" & 1"

Lite10 spacers are stackable and available in widths of 1/4", 3/8", 1/2" and 3/4".

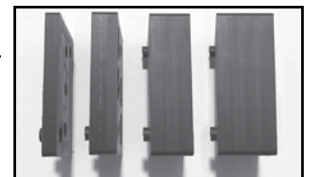

Versatile post options let you achieve the look you desire



- SS CONNECTORS ON EXISTING WOOD POSTS
- 10mm TEMPERED SAFETY GLASS



- 2 1/4" ALUMINUM VISTI POSTS
- LITE 10 (NYLON) CONNECTORS
- 10mm TEMPERED SAFETY GLASS



- BLACK ALUMINUM INVISIPOSTS
- SS CONNECTORS
- 10mm TEMPERED SAFETY GLASS



Fascia-mount Visti post in black



Fascia-mount InvisiPost in white



5/16 X 3" heavy duty concrete anchor

5/16 X 6" hardened steel construction screws



- FASCIA-MOUNT SS INVISIPOSTS
- SS CONNECTORS
- 10mm TEMPERED SAFETY GLASS

Custom glass solutions



- CUSTOM SS HINGE PLACEMENT
- HYDRAULIC SELF-CLOSING HINGES
- 10mm TEMPERED SAFETY GLASS



- CUSTOM SHAPED 10mm TEMPERED SAFETY GLASS
- 54" TALL SS POSTS
- SS CONNECTORS



- BLACK TINTED 10mm TEMPERED SAFETY GLASS
- MATTE BLACK ALUMINUM INVISIPOSTS
- BLACK SS CONNECTORS



- CUSTOM SHAPED PRIVACY WALL
- 10mm ACID ETCHED (FROSTED) TEMPERED SAFETY GLASS
- SS CONNECTORS ON WOOD POSTS

Budget friendly post and baluster combinations

Seamlessly transition to baluster rail on your stairs to save time and money on your project.

Our Deckorators ALX posts can be ordered with matching baluster kits. Available in textured black, textured white or brushed aluminum finishes.

- 2 1/2" ALX BRUSHED ALUMINUM POSTS
- LIGHTED POST CAPS
- SS CONNECTORS
- 10mm TEMPERED SAFETY GLASS
- ALX CONTEMPORARY SQUARE BALUSTER KITS

- 2 1/2" ALX BRUSHED ALUMINUM POSTS
- SS CONNECTORS
- 10mm TEMPERED SAFETY GLASS
- ALX CONTEMPORARY ROUND STAIR KIT



- SS INVISIPOSTS
- SS CONNECTORS
- 10mm TEMPERED SAFETY GLASS

- 2 1/2" ALX BRUSHED ALUMINUM POSTS
- ALX CONTEMPORARY STAIR RAIL KIT

For the ultimate backyard pool



- SS CONNECTORS ON EXISTING WOOD POSTS
- 10mm TEMPERED SAFETY GLASS



- 2 3/8" SQUARE SS POSTS
- SS CONNECTORS
- 54" HEIGHT 10mm TEMPERED SAFETY GLASS



Lockable gates feature heavy-duty self-closing hydraulic dampening hinges

Safety, security and perfect sightlines are what you want in a pool enclosure. The InvisiRail pool system provides all this and more.

Available in any glass height to meet local building code requirement



- 54" HEIGHT SS INVISIPOSTS
- SS CONNECTORS
- 54" HEIGHT 10mm TEMPERED SAFETY GLASS

Distinctive interior railing

If you thought our glass railing system was just for outdoor applications then think again!

InvisiRail is a perfect choice for interiors where you want a brighter look and more spacious feeling.

Add beauty and value to your home without sacrificing the safety of your loved ones.

- SS INVISIPOSTS
- SS CONNECTORS
- 10mm TEMPERED SAFETY GLASS

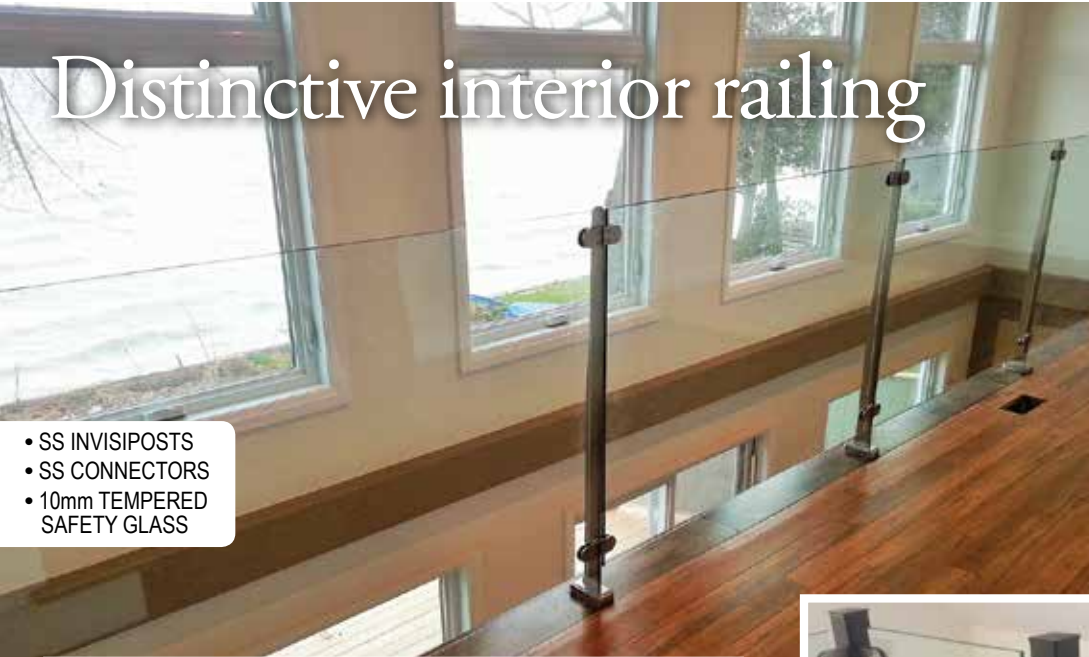

- BLACK ALUMINUM INVISIPOSTS
- SS CONNECTORS
- 10mm TEMPERED SAFETY GLASS



- 2 1/4" ALUMINUM VISTI POSTS
- SS CONNECTORS & HAND RAIL
- 10mm TEMPERED SAFETY GLASS

Stainless steel hand rail

- SS INVISIPOSTS
- SS CONNECTORS & HAND RAIL
- 10mm ACID ETCHED (FROSTED) TEMPERED SAFETY GLASS



Wall-mount, glass-mount and post-mount options available for 42mm (1 5/8") diameter and 50mm (2") diameter stainless pipe.

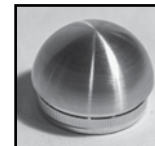

Choose end caps or 90-degree returns.



Joiners and pivots allow continuous rail along any shape and distance.

Wide-open viewing with spigots and stand offs

Give your project an ultra-modern look with 12mm thick glass mounted with spigots or stand offs.

Optional 1 5/8" round top rail meets building code requirements.

Railing heights of up to 60" made to order.

- POWDER-COATED SS SPIGOTS
- 12mm TEMPERED SAFETY GLASS

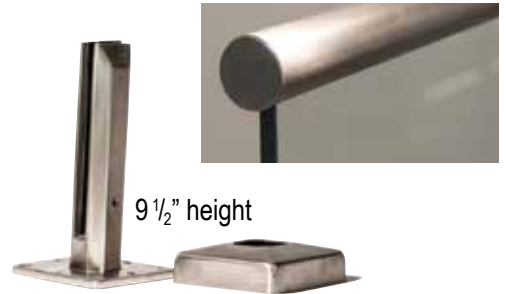

- SS SPIGOTS
- 12mm TEMPERED SAFETY GLASS

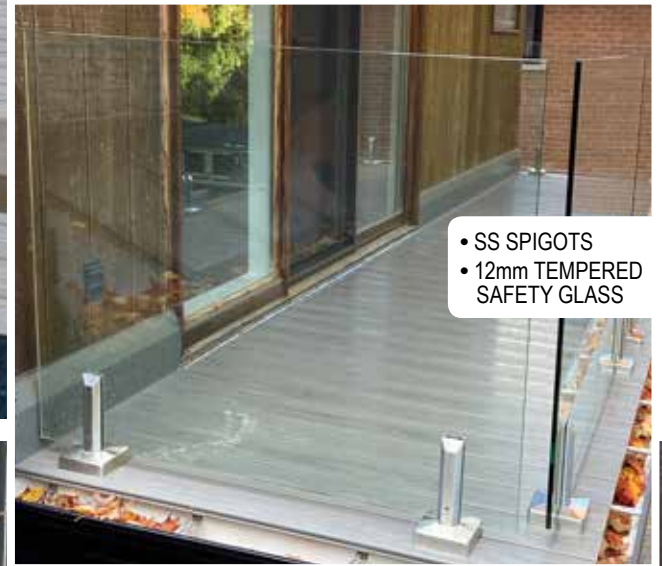

- SS STAND OFFS
- 12mm TEMPERED SAFETY GLASS

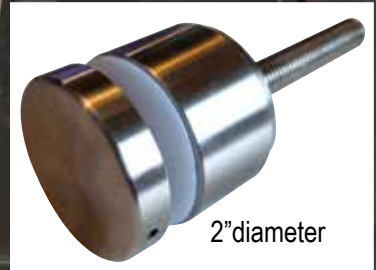

Stainless steel cable railing

- 2 3/8" SQUARE SS START / FINISH POSTS
- SS INVISIPOST MID-POSTS
- SS INTERMEDIATE SPACERS
- 1/8" 1X19 SS CABLE



Easy to install cable railing offers both high visibility and great air circulation. Available in 36" height and 42" height. All material is marine grade 316 stainless steel for low maintenance and lasting beauty.



Store Name:

Contact Name: Phone #:

Email:

Project Name: **PROVIDE A LAYOUT SKETCH ALONG WITH THIS SHEET**

QUOTE REQUEST

sales@invisirail.com

Toll Free: 1-888-681-9733 | Fax: 905-852-5196

GLASS *check one* 10mm for posts & connectors 12mm for spigots & stand offs * Low Iron * Frosted * Tinted *

RAIL HEIGHT *check one* 42" (standard) 36" * other * _____ (provide desired rail height)

POSTS *check one*

INVISIPOST

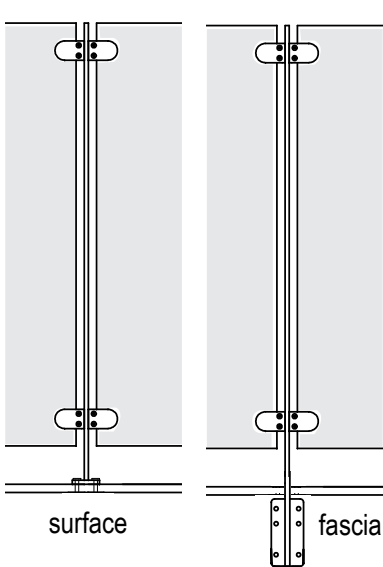

VISTI POST

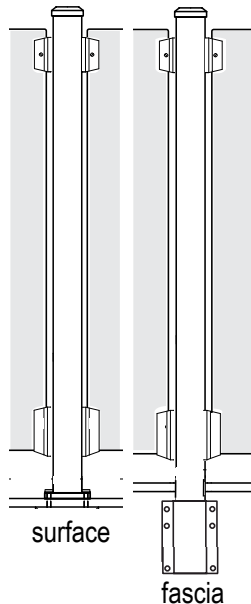

- Surface-mount VISTI Post, 2 1/4", Black Powder-Coated Aluminum
- Surface-mount VISTI Post, 2 1/4", White Powder-Coated Aluminum
- Fascia-mount VISTI Post, 2 1/4", Black Powder-Coated Aluminum
- Fascia-mount VISTI Post, 2 1/4", White Powder-Coated Aluminum
- Surface-mount ALX Brushed Titanium (Aluminum), 2 1/2"
- Surface-mount INVISIPOST, Stainless Steel
- Surface-mount INVISIPOST, Black powder-coated aluminum
- Surface-mount INVISIPOST, White powder-coated aluminum
- Fascia-mount INVISIPOST, Stainless Steel
- Fascia-mount INVISIPOST, Black powder-coated aluminum
- Fascia-mount INVISIPOST, White powder-coated aluminum
- 4X4 (or other) Wood Posts - *Not available from InvisiRail*

CONNECTORS *check one*

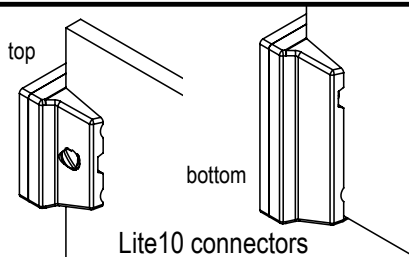
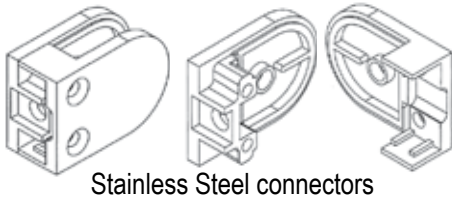

NOTE: *Stainless Steel is the only option for InvisiPosts*

- Lite10 (nylon), Black
- Lite10 (nylon), White
- Stainless Steel, standard brushed finish
- Stainless Steel, Black PVD finish
- Stainless Steel, powder-coated finish*

SPIGOTS *check one*

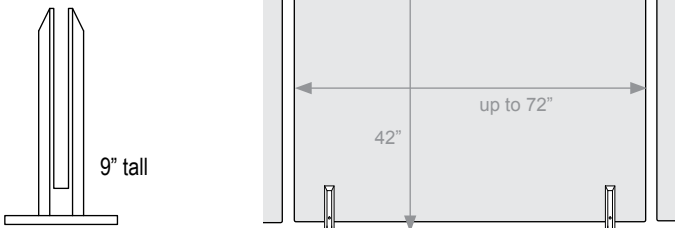

- Stainless Steel, standard brushed finish
- Stainless Steel, Black powder-coated finish *

STAND OFFS

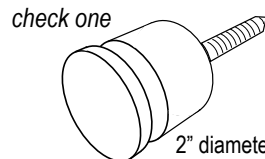

- Stainless Steel, standard brushed finish
- Stainless Steel, Black powder-coated finish *

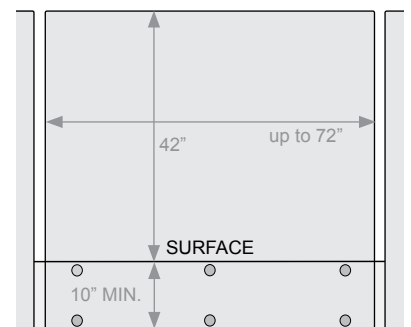

STAIR RAIL *check one* Custom glass (template req'd)* Aluminum balusters (pickets) None

GATE *check one*

Glass Aluminum None
_____ (width)

STAIR SECONDARY HAND RAIL *check one*

SS 1 5/8" pipe Black / White Aluminum None

HORIZONTAL TOP RAIL *check one*

SS 1 5/8" pipe deck board None

* EXPECT LONGER WAIT TIMES



Care and Maintenance

In most applications, stainless steel will not rust or stain. However, when stainless steel comes in contact with chloride salts, sulphides or other rusting metals, it can discolour or even rust and corrode.

To maintain the beauty and function of stainless steel for years to come you must:

- Clean stainless steel with soap and water
- Never use mineral acids, bleaches or coarse abrasives
- Always remove stains or tarnish as soon as possible with either soap and water or a stainless steel cleaner like Barkeepers Friend or CitriSurf .

Visit us at invisirail.com to find the dealer nearest to you!

AVAILABLE AT:

FOLLOW • LEARN • LIKE

